

STANDARD Panel Profiles

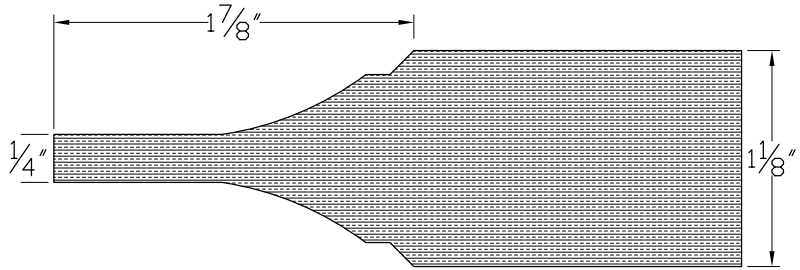

Profile # R118A

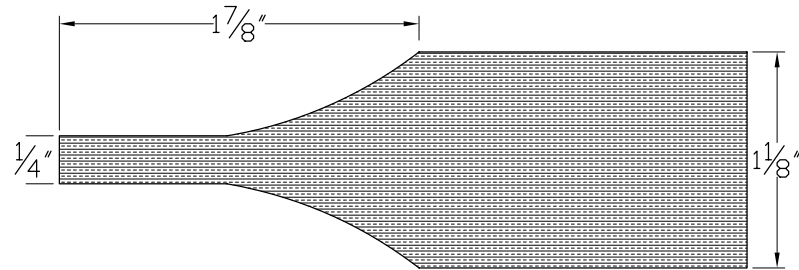

Profile # R118A (Single Scoop)

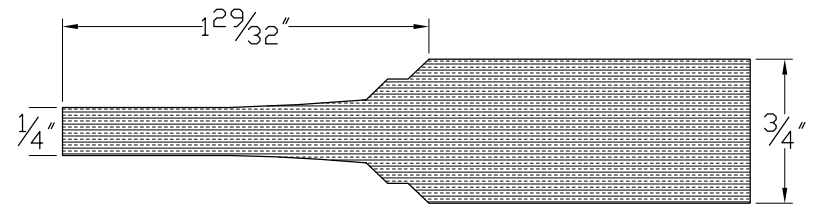

Profile # R34A

OPTIONAL Panel Profiles

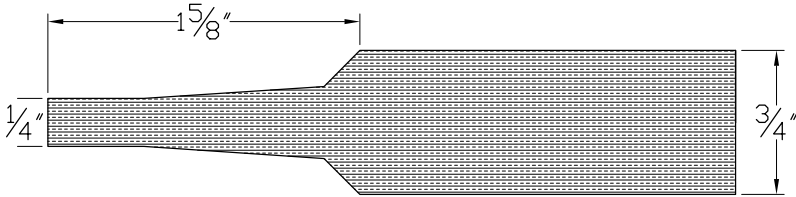

Profile # R34-L1

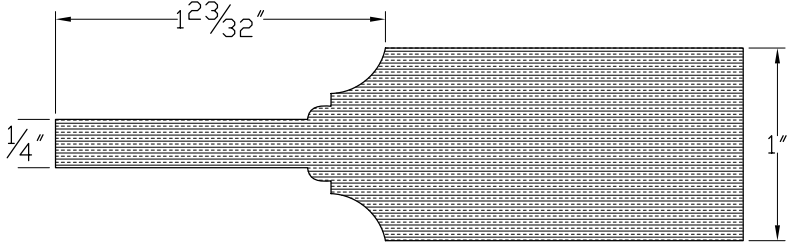

Profile # R100-L1

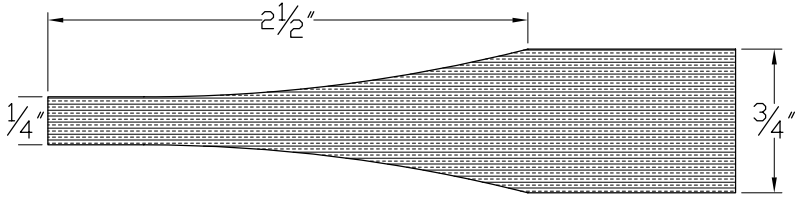

Profile # R34-L2

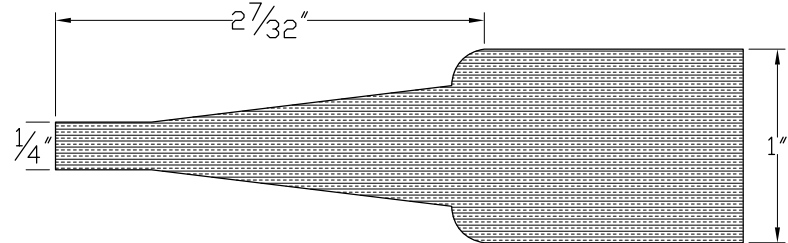

Profile # R100-L2

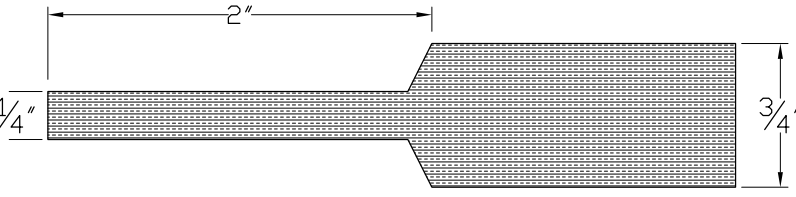

Profile # R34-L3

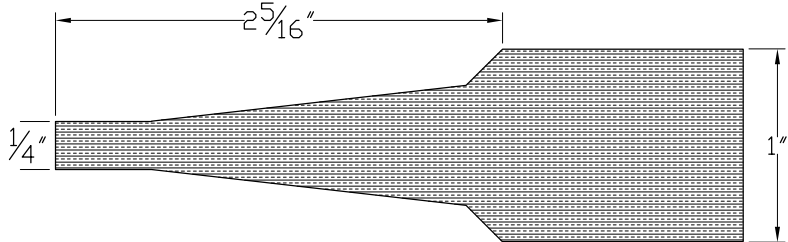

Profile # R100-L3

OPTIONAL Panel Profiles

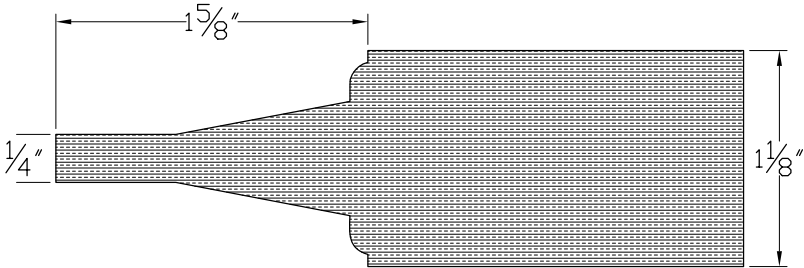

Profile # R118-L1

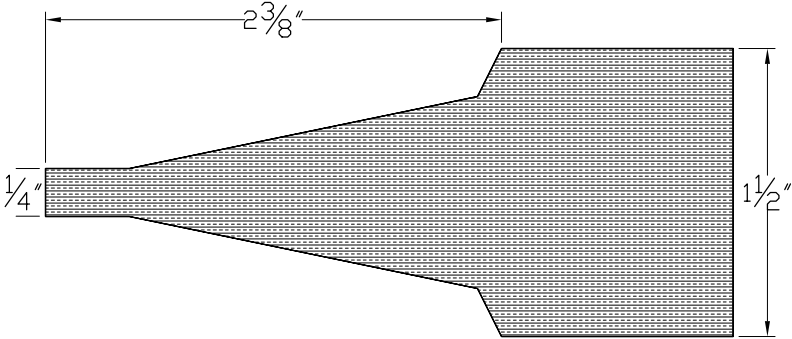

Profile # R112-L1

OPTIONAL Panel Profiles

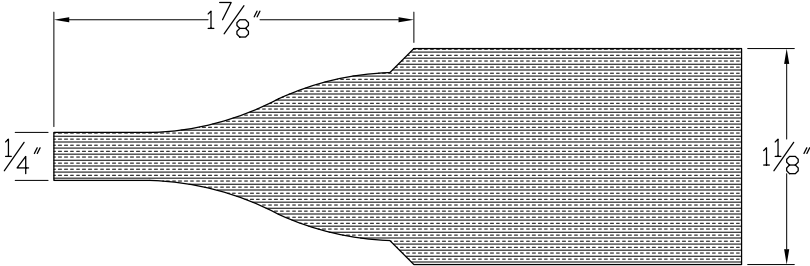

Profile # R118-S1

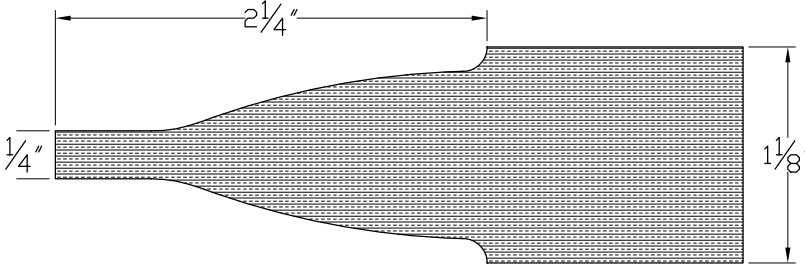

Profile # R118-S2

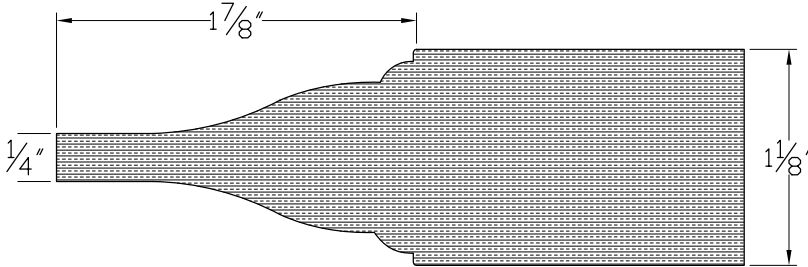

Profile # R118-S3

OPTIONAL Panel Profiles

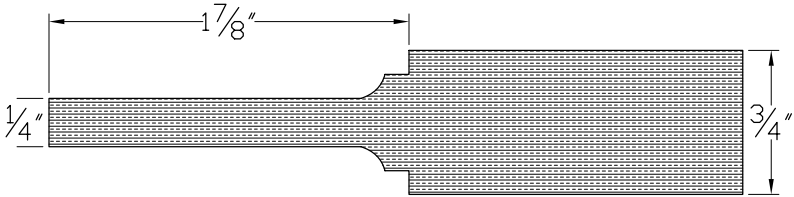

Profile # R34-V1

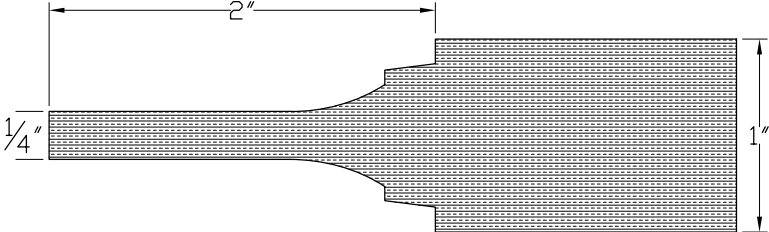

Profile # R100-V1

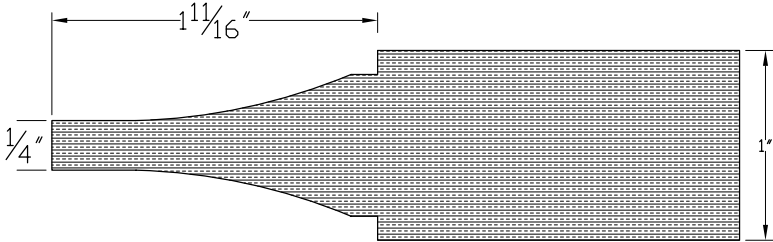

Profile # R100-V2

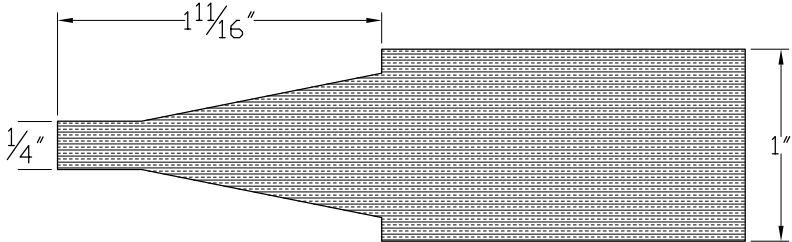

Profile # R100-V3

OPTIONAL Panel Profiles

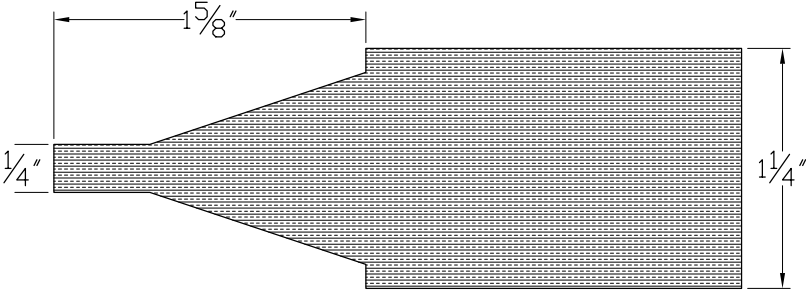

Profile # R114-V1

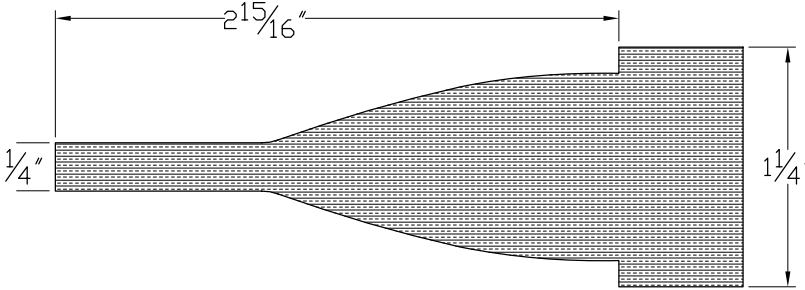

Profile # R114-V2

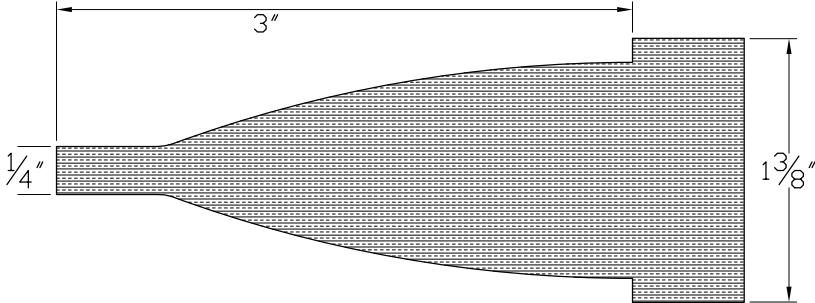

Profile # R138-V1